

FAG

6202-C-2Z

Deep groove ball bearing

Schaeffler ID:
0953606540000

Deep groove ball bearing 62...-C-2Z, single row, Generation C, shields, steel sheet metal cage

Technical information

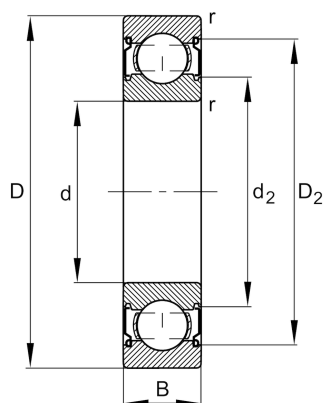
**Dimensions**

r_{\min}	0.6 mm	Minimum chamfer dimension
D_2	30.9 mm	Caliber diameter outer ring
d_2	20.1 mm	Caliber diameter inner ring
	0.044 kg	Weight

Main Dimensions & Performance Data

d	15 mm	Bore diameter
D	35 mm	Outside diameter
B	11 mm	Width
C_r	8,900 N	Basic dynamic load rating, radial
C_{0r}	3,750 N	Basic static load rating, radial
C_{ur}	260 N	Fatigue load limit, radial
n_G	28,000 1/min	Limiting speed
n_{gr}	21,900 1/min	Reference speed

Mounting dimensions

$d_{a\min}$	19.2 mm	Minimum diameter shaft shoulder
$D_{a\max}$	30.8 mm	Maximum diameter of housing shoulder
$r_{a\max}$	0.6 mm	Maximum fillet radius

Calculation factors

f_0	13	Calculation factor
-------	----	--------------------

Temperature range

T_{\min}	-20 °C	Operating temperature min.
T_{\max}	120 °C	Operating temperature max.

